

## 0. Overview of the parts.

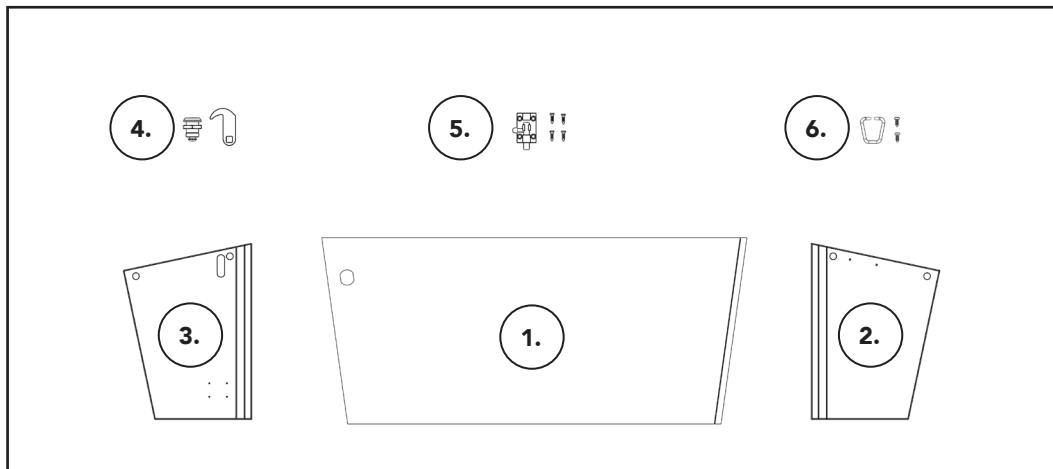

1.

Front panel

2.

Right panel

3.

Left panel

4.

Lock

5.

Sliding lock

6.

Shackle

## Step 1. Remove the existing parts

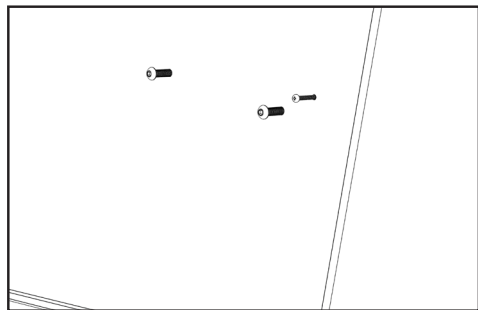

Remove: the existing seat and supports on the left and the right side, remove the bolts for the seat belt and remove the bench magnet from the side panel and the bench.

## Step 2. Pre-assembly left panel

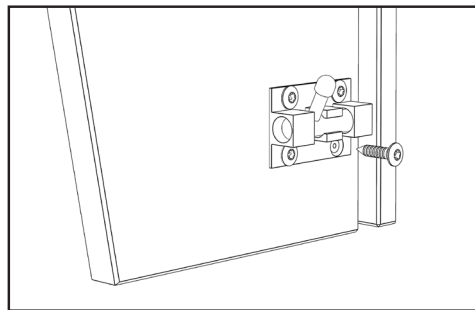

Mount the sliding lock (5) on the left panel (3) with the 4 small screws (2.5x12mm).

*Note: The existing bolts (+ magnet) will be reused when installing the new parts.*

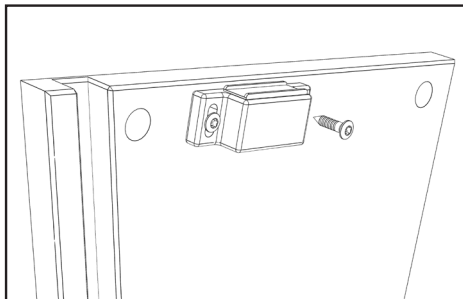
**Step 3. Pre-assembly right panel**

Mount the first part of the benchmagnet on the right panel (2) with existing screws.

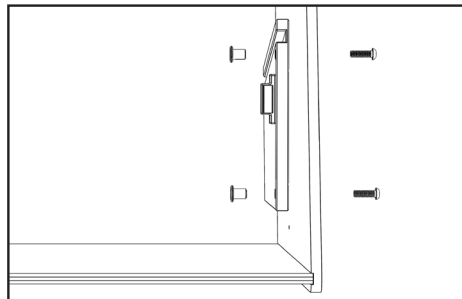
**Step 4. Mount the side panels**

Mount the left and the right panel (2/3) in the bin with the existing screws.

**Step 5. Only for cargo bike short**

Shorten the front panel (1) by cutting along the line. Tip: use a iron saw or a saw with small teeth to prevent splintering of the wood.

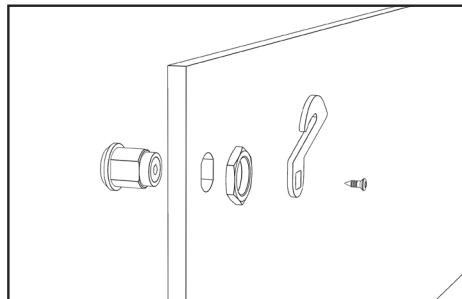
**Step 6. Pre-assembly front panel**

Mount the lock (4) on the front panel(1). Make sure that the hook is facing upwards in the locking position of the lock.

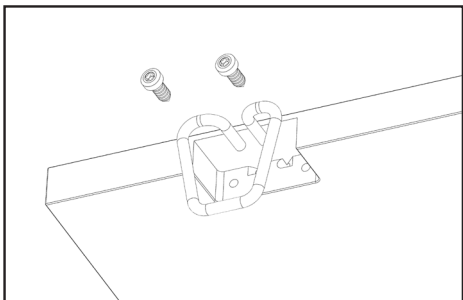
**Step 7. Pre-assembly of the bench**

Mount the shackle (6) on the bench with the included screws. Also mount the second part of the bench magnet with the existing screws.

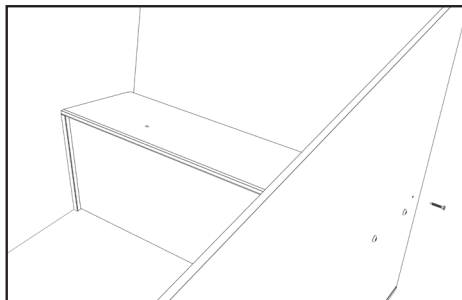
**Step 8. Mount the bench**

Mount the Bench in the bin with the existing screws.